

MTN-BW50

Intel Broadwell/Haswell Processor based Compact Mini PC



Features

- CPU: Intel Haswell/Broadwell Processors
- Memory: Dual Channel DDR3L for Memory up to 16GB
- Display: Intel HD Graphics, Displays via 2xHDMI
- I/O Ports: 3xUSB3.2, 2xUSB2.0, 1xLAN, Audio
- Expansion: 1x M.2 for WiFi
- Storage: 1xM.2 for SSD, SATA3.0
- Power: 12V DC-in



IoT Solutions
Alliance
**Industrial Solution
Builders Specialist**

Introduction

The Maxtang MTN-BW50 is a compact mini PC based on the Intel Broadwell/Haswell processors, i5-4200U, i3-5005U, i7-5500U, provides excellent performance with greater space-saving. Supports Dual-channel DDR3L up to 16GB, display via 2xHDMI. Features with one 10/100/1000 Mbps ethernet controller, M.2 and SATA3.0 for storage, addition M.2 for Wi-Fi. A rich I/O interface includes 3x USB3.2, 2xUSB2.0, 1xLAN, Line-out, Mic-in with standard 12V DC-in caters to most markets requirements.

The MTN-BW50 is an ideal solution for various applications. It retains the robust design of all Maxtang product lines at a new cost-effective price point. Its powerful features provide you an outstanding visual experience, increase your productivity with stability, reliability. Our goal is to provide the best products with high quality and cost advantages.

I/O Interfaces

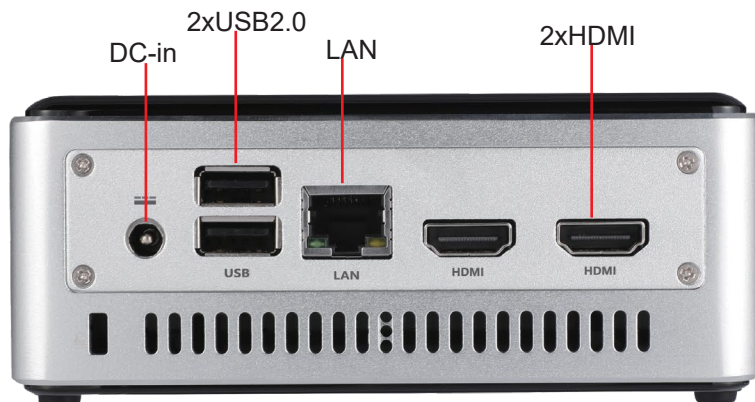
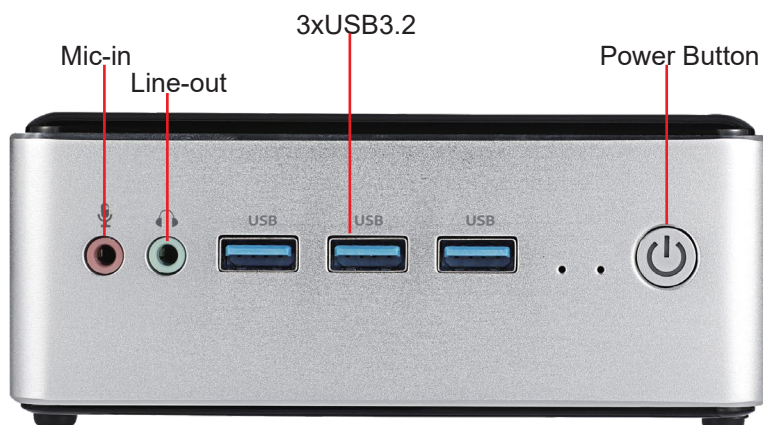

H/W Monitor



Watchdog



GPIO



Brightness



Wi-Fi



Bluetooth

Technical Specifications

Processor	CPU	i3-5005U	i5-4200U	i7-5500U
	Core Frequency	2.00 GHz	1.60 GHz	2.40 GHz
	Max Turbo Frequency	/ GHz	2.60 GHz	3.00 GHz
	Cache	3 MB	3 MB	4 MB
	BIOS	AMI UEFI BIOS		
Memory	Type	Dual Channel SO-DIMM DDR3L		
	Max Capacity	16GB		
Display	GPU	Intel® HD Graphics based on CPU		
	Display Port	2x HDMI		
Ethernet	Speed	10/100/1000 Mbps		
	Controller	RTL8111H		
	Interface	RJ-45		
Audio	Audio Codec	Realtek HD		
	Interface	1xLine-out+1xMic-in,Audio header, Amplifier header		
Hardware		CPU temperature, system temperature, onboard voltage, watchdog		
Storage	M.2	1x M.2 for 2280 SSD		
	SATA3.0	1x SATA3.0 (2.5inches)		
Expansion	M.2	1x M.2 for Wi-Fi		
I/O Interface	HDMI	2		
	USB2.0	2		
	USB3.2	3		
	LAN	1		
	Line-out	1		
	Mic-in	1		
	DC-in	1		
	Dimension	Size	130 mm x 128 mm x 52mm (L x W x H)	
Power	Standard Port	12V DC-in		
Temperature	Operating Temp.	-20°C to 60°C		
	Storage Temp.	-20°C to 80°C		
Cooling		Active		
Operating System		Win 7/8/10 64bit, Linux 64bit		

*All specifications and photos are subject to change without notice.

Dimension(in mm)

① Mic-in

② Line-out

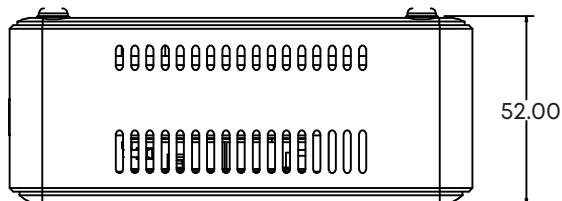

⑤ 2x HDMI

⑥ LAN

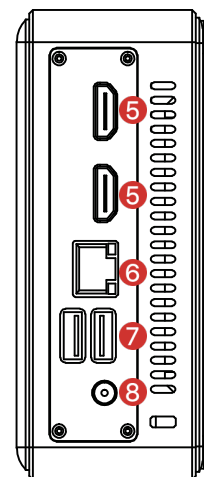
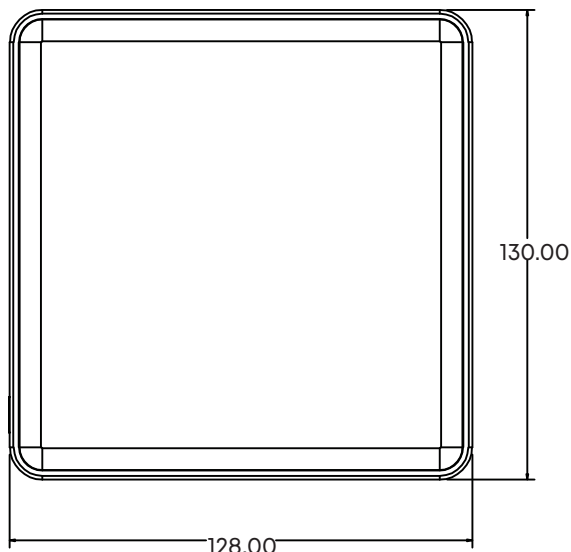
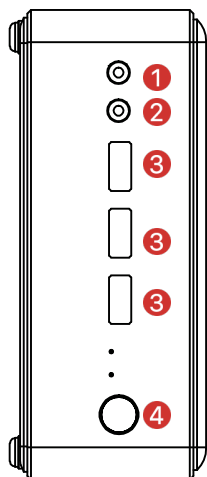

③ 3x USB3.2

④ Power button (with LED)

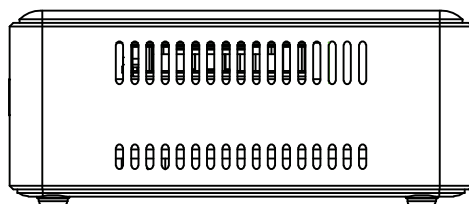

⑦ 2x USB2.0

⑧ DC-in

Copyright ©2018 Maxtang Technology Co. Ltd. All rights reserved. All data is for information purposes only and not guaranteed for legal purposes. Information has been carefully checked and is believed to be accurate however, no responsibility is assumed for inaccuracies. Maxtang and the Maxtang logo and all other trademarks or registered trademarks are the property of their respective owners and are recognized.